

## Frozen Frozen granita and cream dispenser with 2 insulated bowls, LED light

ITEM # \_\_\_\_\_

MODEL # \_\_\_\_\_

NAME # \_\_\_\_\_

SIS # \_\_\_\_\_

AIA # \_\_\_\_\_

**560100 (SP2NewL)**

 Frozen Granita and Frozen  
 Cream Dispenser with 2x5 l  
 insulated bowls and LED  
 light, R290

### Short Form Specification

**Item No.** \_\_\_\_\_

2x5 lt bowl frozen granita and frozen cream dispenser. Ideal for the production of chilled specialties: creamy desserts, sherbets, mousses and similar products. Works with water or milk/based dried products or with milk mixtures ready to be poured into the bowl. Compact design. Extremely user-friendly thanks to the screw design for adjusting the consistency of the product. Hybrid control of consistency, it self-adjusts to ensure that the product always has the same consistency. The bowl is illuminated by LED lights. The machine automatically stops when the cover is opened. No ice outside the tank with the insulated tank. Rounded shapes with stainless steel finishings and white plastics. All parts that come into contact with the food are in stainless steel or plastic, can be removed for easy cleaning.

### Main Features

- Ideal for production of chilled specialties: creamy desserts, sorbet, mousses and similar products.
- Works with water or milk/based dried products or with brik mixtures ready to be poured into the bowl.
- Perfect solution for bars, restaurants, cafeterias, coffee shops, hotels and all the other HoReCa operators who desire reliable piece of equipment.
- The machine automatically stops when the cover is opened.
- No more ice or condensation outside the tank with the insulated tank.
- Rounded shapes with stainless steel finishing and white plastics.
- Thanks to the two-bowl configurations, it is possible to simultaneously prepare one or more products.
- The insulated tank guarantees higher cooling efficiency and lower effect of the external temperature on product's preparation and maintenance time reducing condense and draining; it is the best solution in hot climate conditions.
- New design of the screw to adjust the product consistency makes the equipment extremely user-friendly.
- Hybrid control of consistency. The integrated software allows the equipment to self-adjust to ensure that the product has always the same consistency, from the first to the last drop dispensed.
- The bowl of SP ULTRA is also illuminated by LED lights, from above and below, giving the equipment a more attractive look, enhancing the product, increasing its visibility and encouraging impulse purchases.

### Construction

- All parts that are in contact with food are in stainless steel or plastic, can be removed for easy cleaning and are dishwasher safe.
- Compact design.

**APPROVAL:** \_\_\_\_\_



**Electrolux**  
PROFESSIONAL

## Frozen Frozen granita and cream dispenser with 2 insulated bowls, LED light

Front

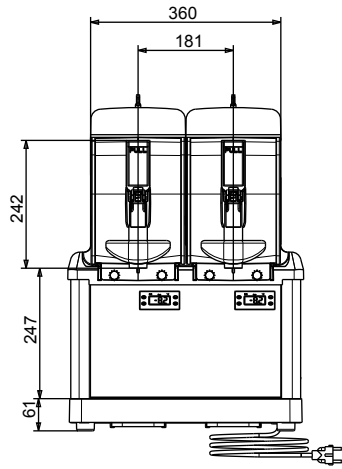

Side

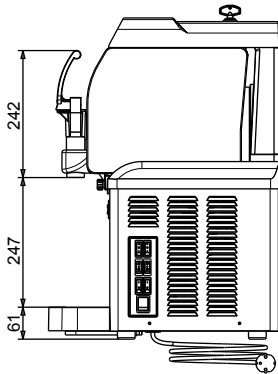

Top

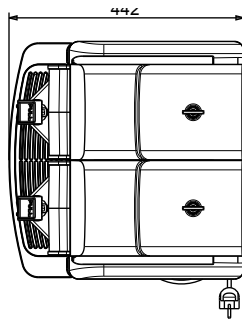

### Electric

Supply voltage:

560100 (SP2NewL) 220-240 V/1 ph/50 Hz

Electrical power max.:

0.775 kW

### Key Information:

External dimensions, Width: 447 mm

External dimensions, Depth: 442 mm

External dimensions, Height: 613 mm

Net weight: 48 kg

### Sustainability

Refrigerant type: R290

Refrigerant weight: 104 g



Frozen  
Frozen granita and cream dispenser with 2 insulated bowls, LED light

The company reserves the right to make modifications to the products without prior notice. All information correct at time of printing.

2024.12.06